

B



JAY R. SMITH MFG. CO.
 MEMBER OF MORRIS GROUP INTERNATIONAL
 POST OFFICE BOX 3237
 MONTGOMERY, ALABAMA 36109-0237 (USA)
 TEL: 334-277-8520 FAX: 334-272-7396 www.jrsmith.com



MEMBER OF:

LOCATION



PLANTING AREA DRAIN

FOR LARGE AREAS

FUNCTION: Used to drain excess moisture which builds up in large planting or flower boxes. Extra large mesh covered dome insures greater drainage area and prevents soil or stones from entering the drain line.

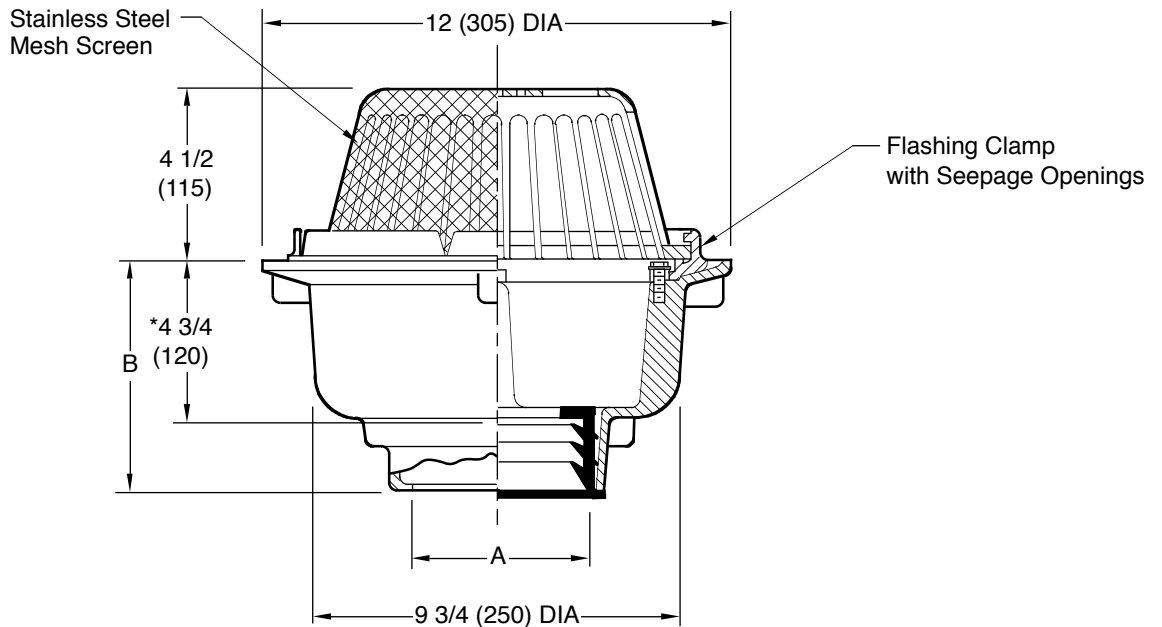
Free Area
 53 SQ IN
 (342) SQ CM



 Fig. 2675C . . . CAULK OUTLET
 Fig. 2675Y . . . NO-HUB OUTLET

*This dimension to Internal Stop of Speedi-Set Gasket.



NOTE: Dimensions shown in parentheses are in millimeters.

A SIZE	02(50)	03(80)	04(100)	05(125)	06(150)
B	6 (150) for Caulk, NO-HUB and Speedi-Set 4 3/4 (120) for Threaded				





REGULARLY FURNISHED:

Duco Cast Iron Body and Flashing Clamp with Polyethylene Dome and Stainless Steel Mesh Screen.

VARIATIONS:

-  L Speedi-Set Service Weight
02(50), 03(80) & 04"(100) sizes only
-  LXH Speedi-Set Extra Heavy
02(50), 03(80) & 04"(100) sizes only
-  T Threaded Outlet

OPTIONAL MATERIALS:

-  Bronze Body -BB
-  Bronze Dome -BD
-  Cast Iron Dome -CID
-  Galvanized Cast Iron -G

DRAWING NUMBER
S2675

SIZE
A

SCALE:
NONE

DATE:
5-17-85

APPROVED BY:
TD

CHECKED BY:
TD

DRAWN BY:
PJ

2675

DIMENSIONS ARE SUBJECT TO MANUFACTURERS TOLERANCE AND CHANGE WITHOUT NOTICE

REV.	DATE	DESCRIPTION	BY	CKD. BY
B	7-7-95	Added Millimeters	EMB	BS
A	11-17-93	Submittal Update	EMB	BS

WEIGHT POUNDS	VOLUME CUBIC FEET
------------------	----------------------

FIGURE NUMBER 2675
